

# CUTTING OUT LETTERS – Working With Symmetry

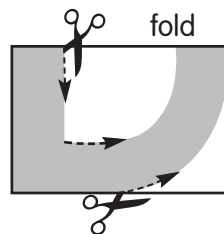

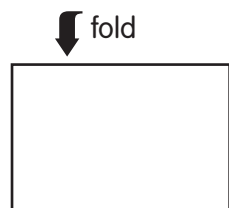

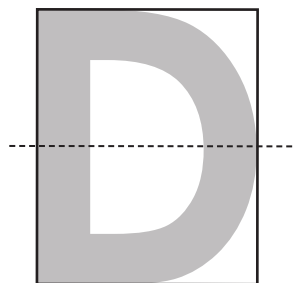

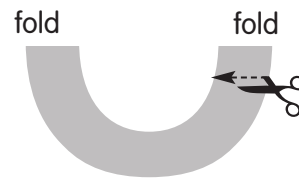
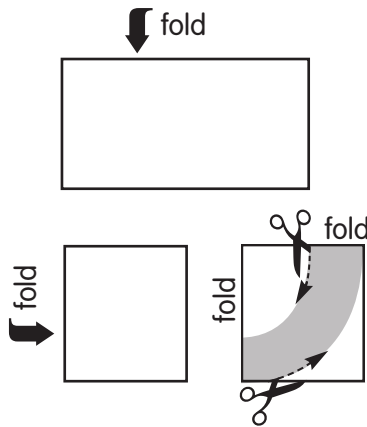
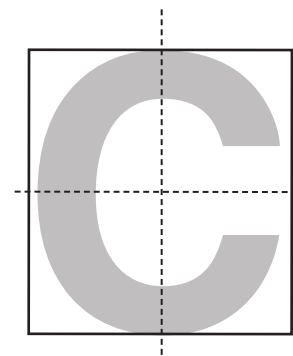
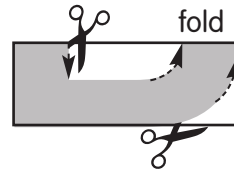
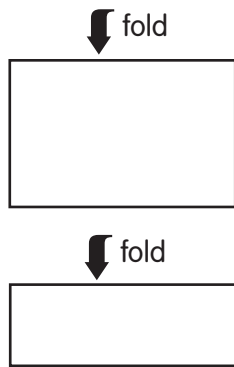
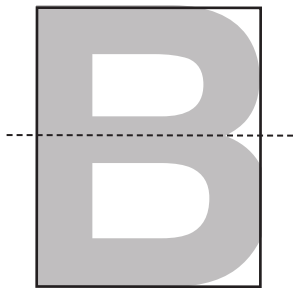
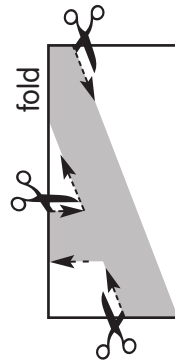
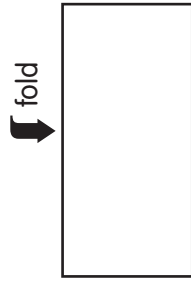
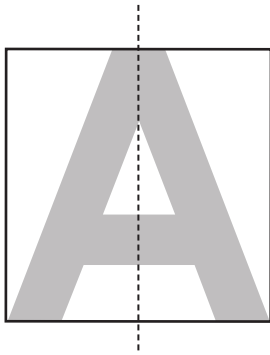
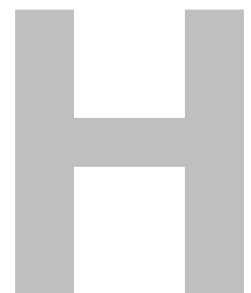
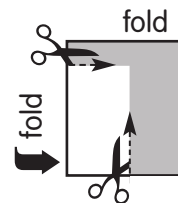
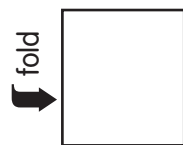
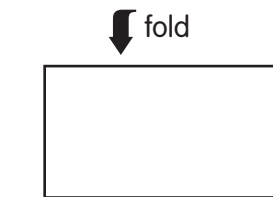
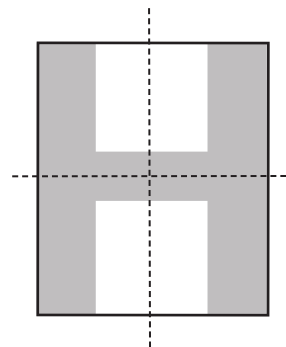
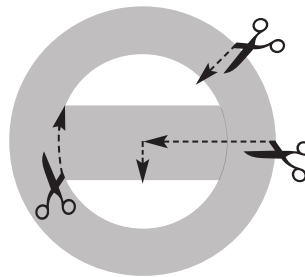
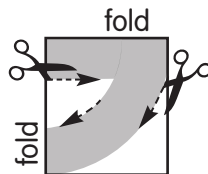
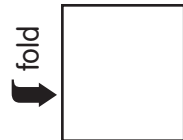
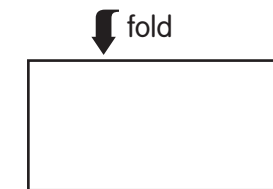
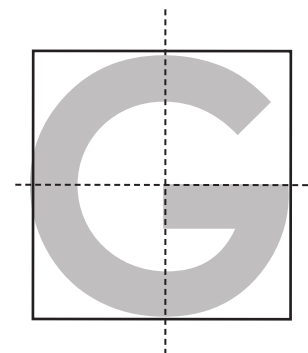
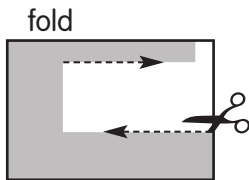
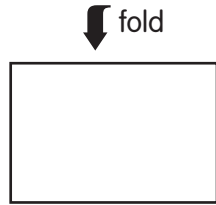
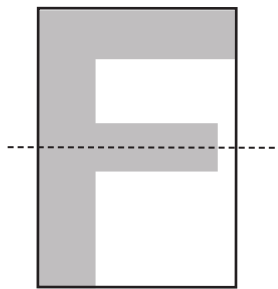
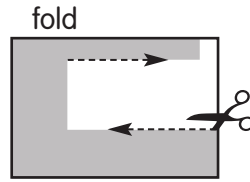
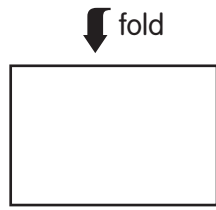
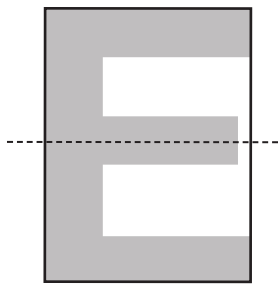
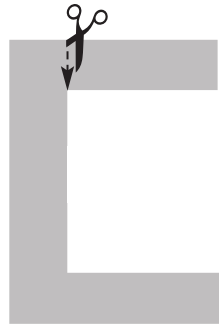
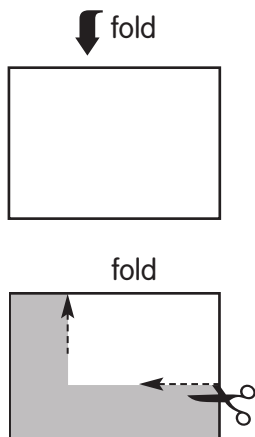
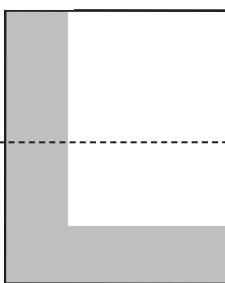
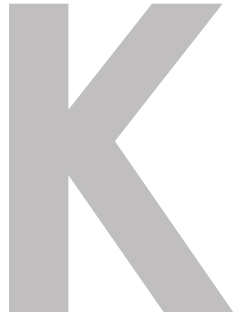
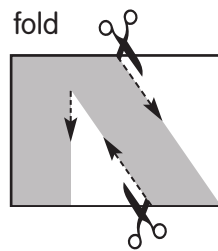
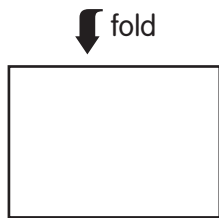
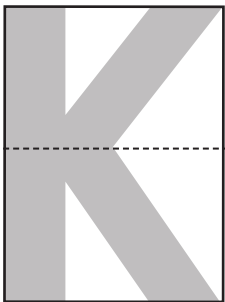
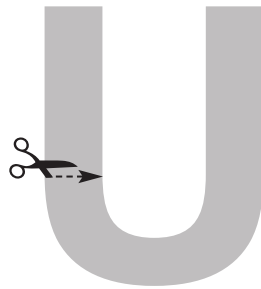
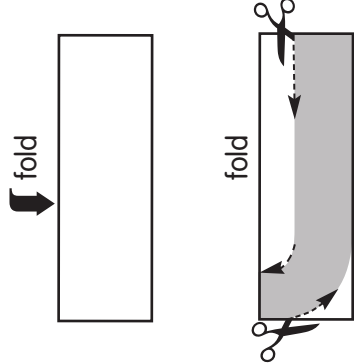
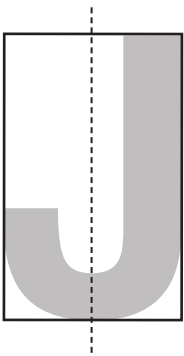
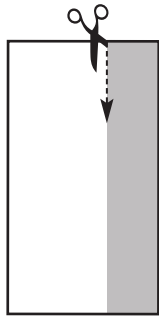
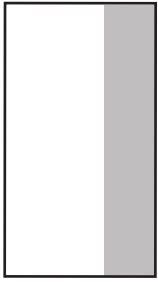
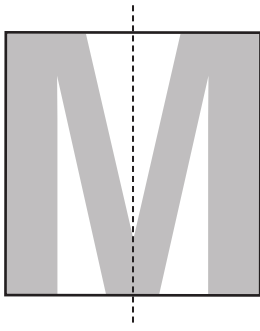

fold

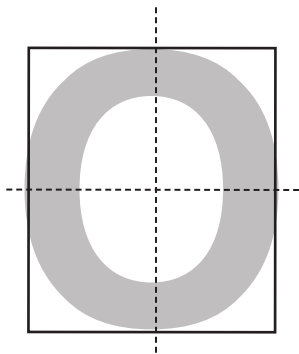
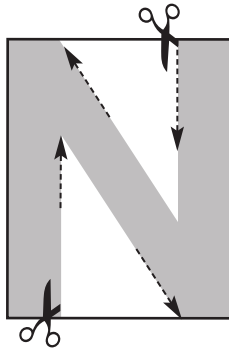
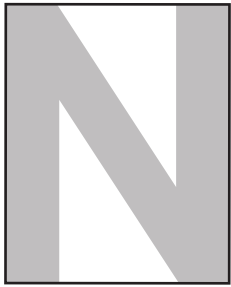
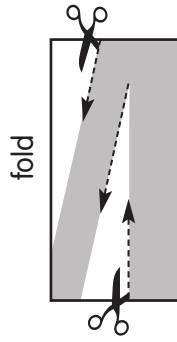
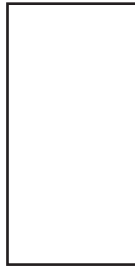

fold



fold

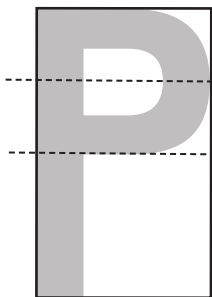
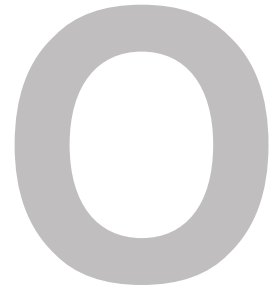
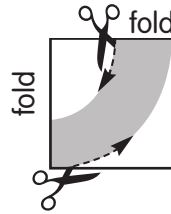
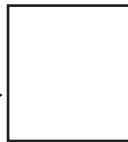

fold

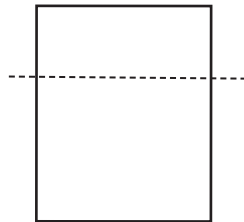

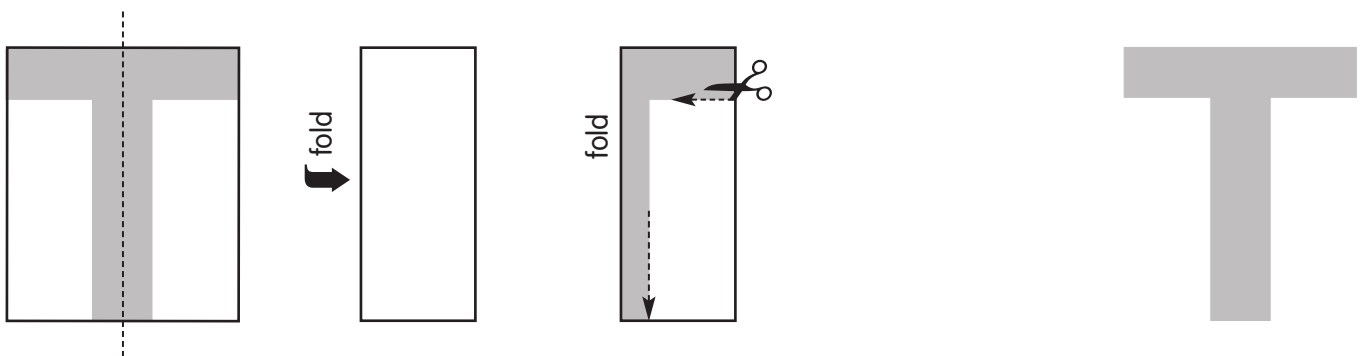
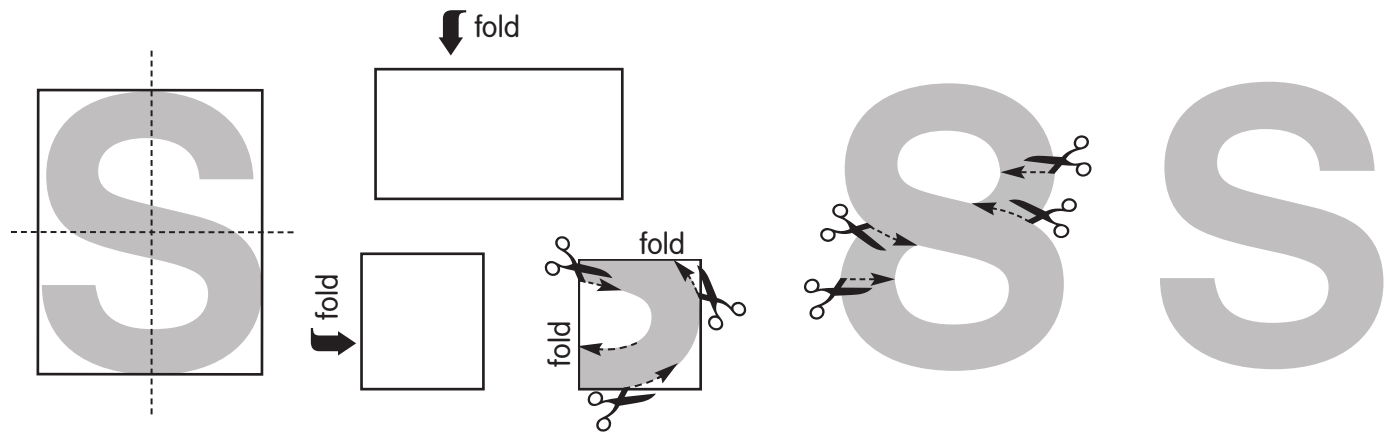
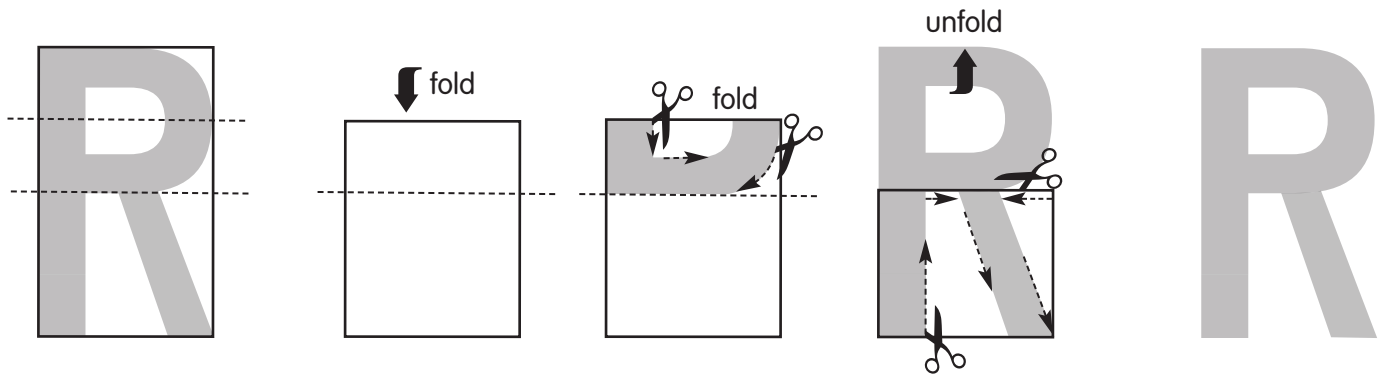
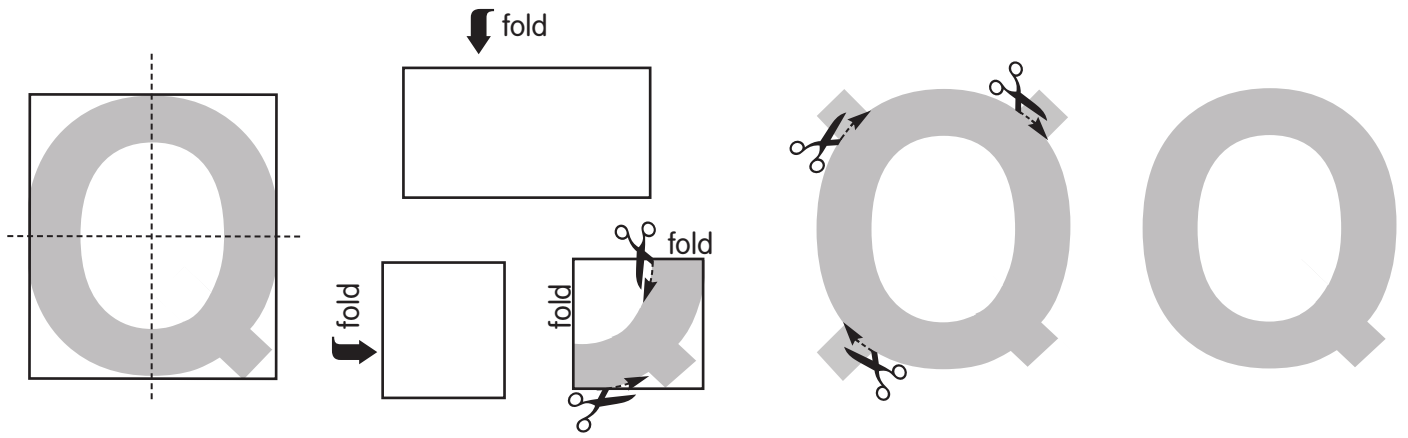

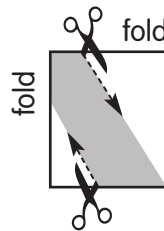
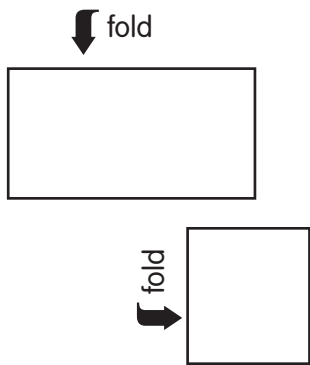
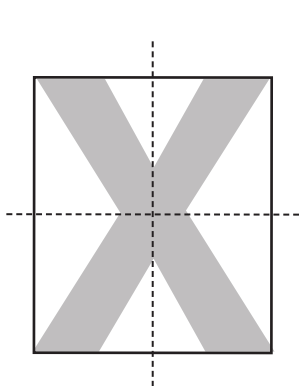
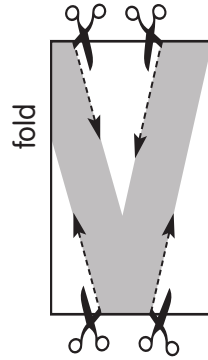
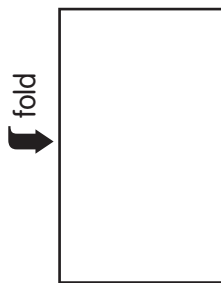
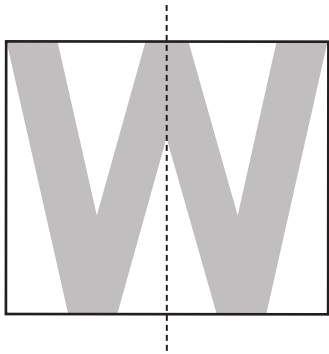
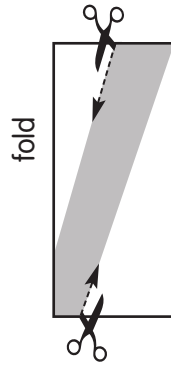
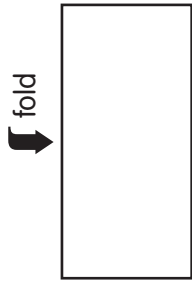
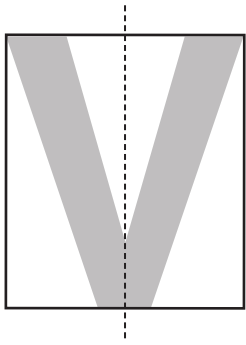
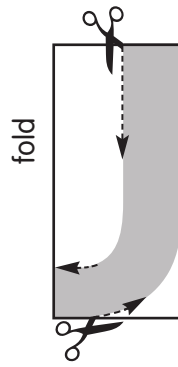
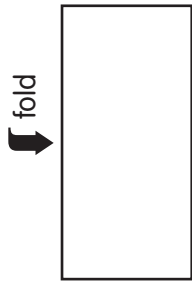
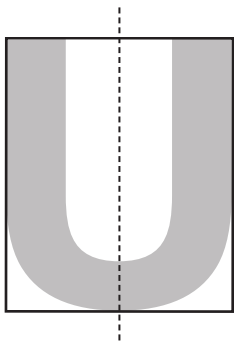

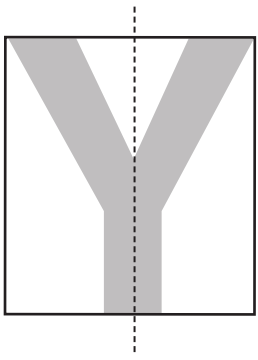

fold

